

INSTRUCTION NOTE

1. Please read this instruction and confirm the specification label on the canopy/
base of the lamp before assembling.
2. Please assemble the lamp according to the illustration and connect to the
power after assembling correctly.
3. Please note the input voltage settings especially when you replace bulbs.
Using wrong bulbs may damage the lamp.
4. If you have any question regarding to the lamp, please contact with local agent.

USER'S INSTRUCTION

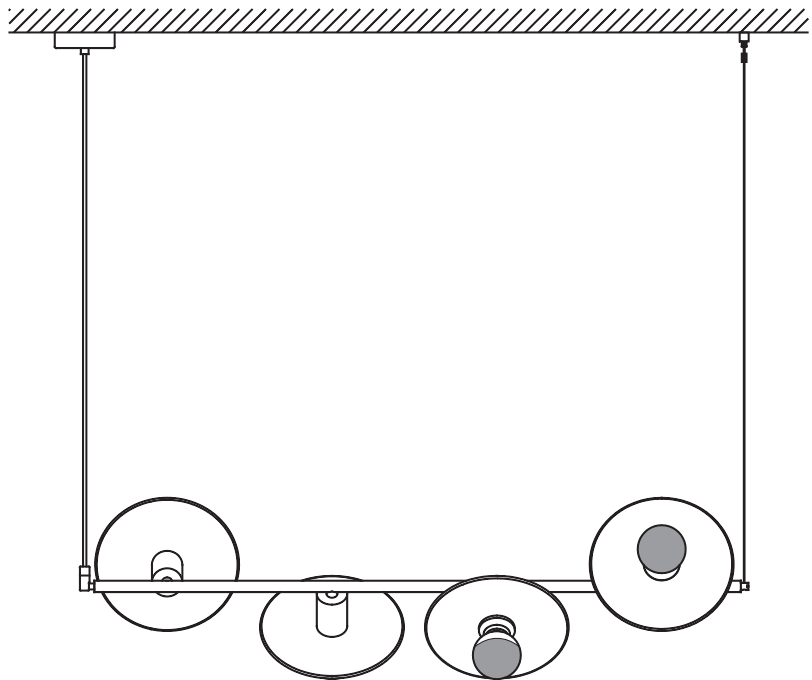

Model: C1242
Bulb: E27 4xMax. 40W
Input voltage: 220-240V~ 50Hz

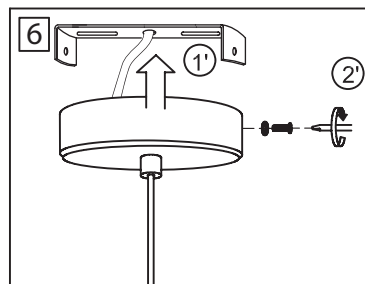
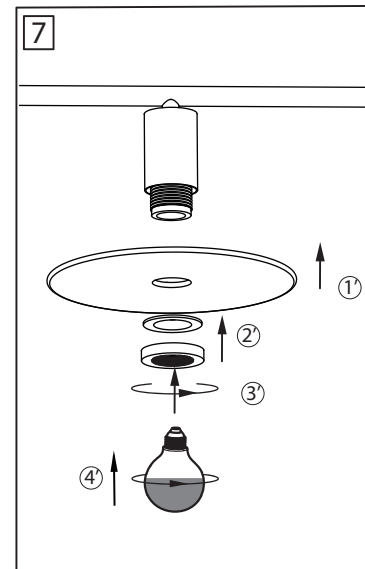
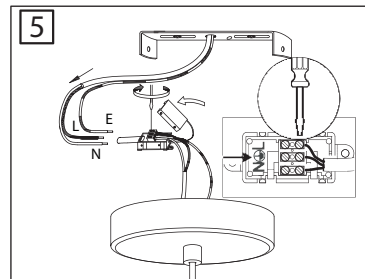
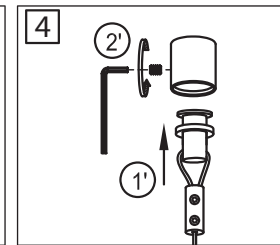
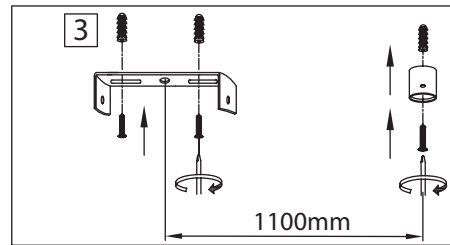
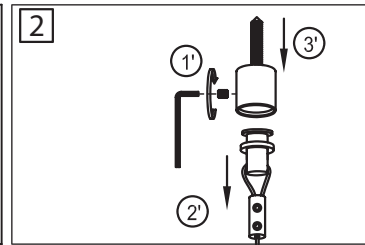
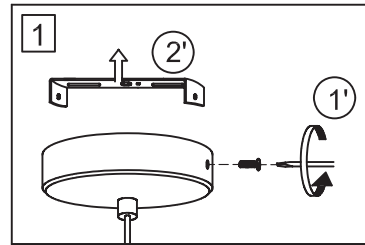

Additional instructions: Adjust the lamp

